

# The Northumberland Swift Box 2023 (Version 3 revised)

(Developed with the support of Alnwick Wildlife Group)

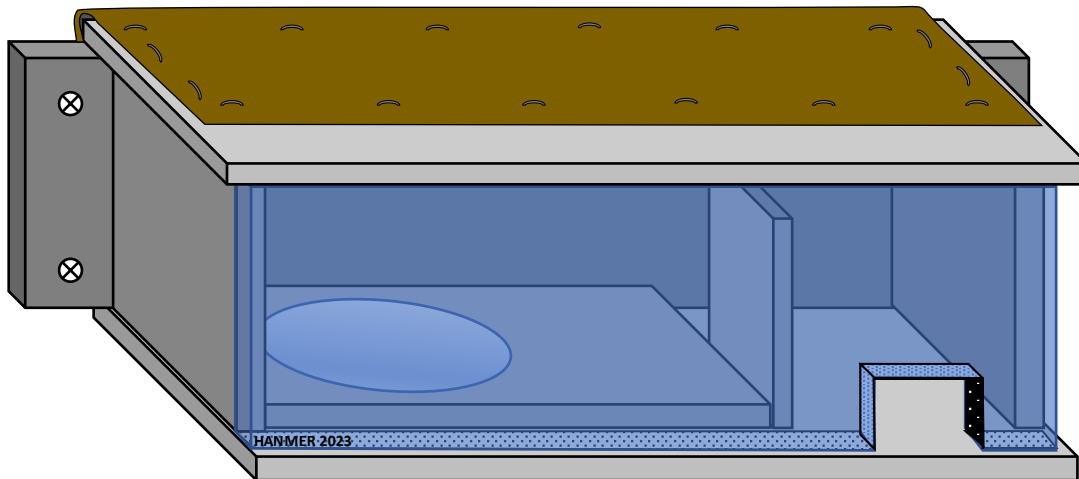

Use plank wood a minimum of 16mm thick.

Locate boxes at least 4m above the ground, with an unobstructed flight path—see possible locations on the diagram.

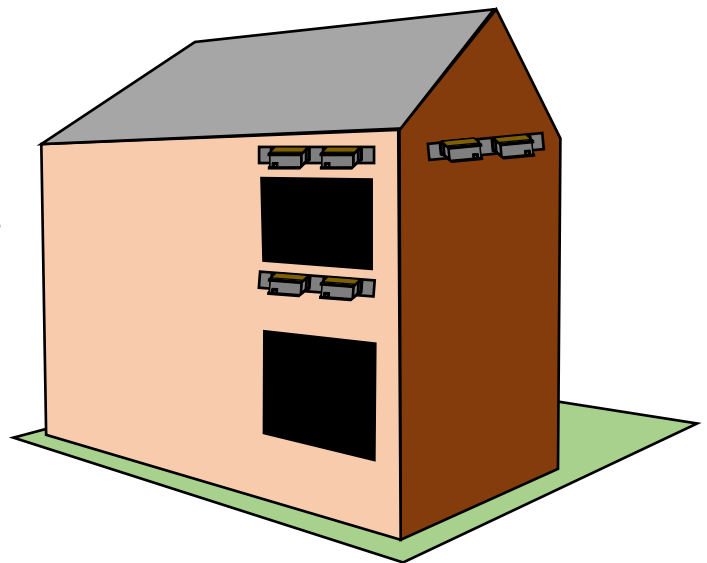

Plan view inside box

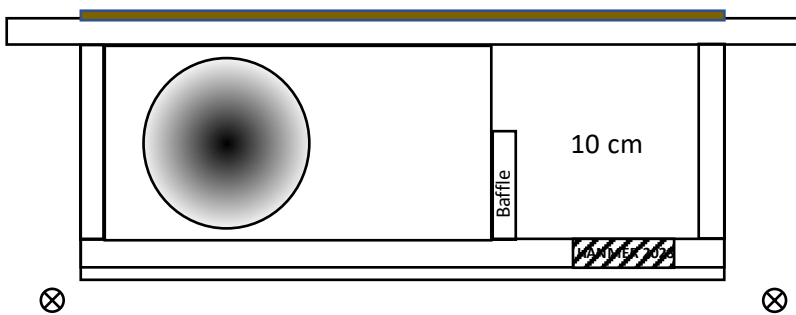

Front view



Side view

Paint the inside of the box with Black matt emulsion paint. Swifts prefer dark nesting places.

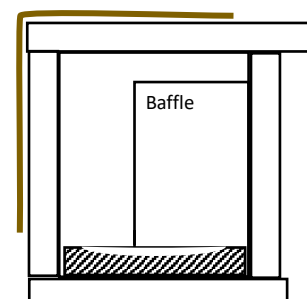

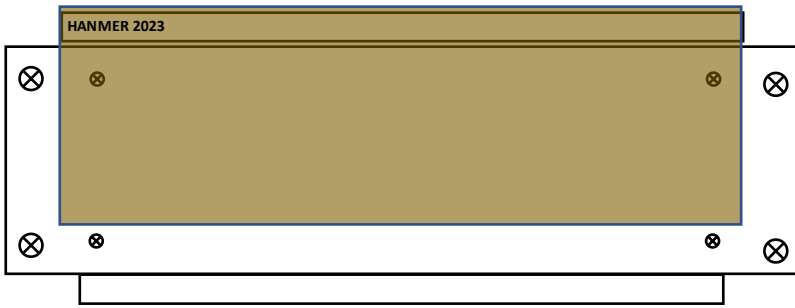

Back view

Roof flashing folded over to make a hinge.

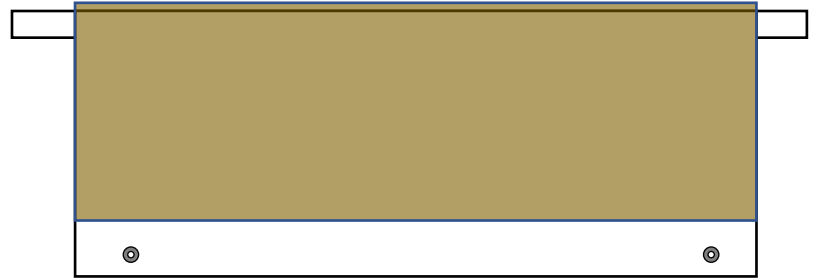

Top view

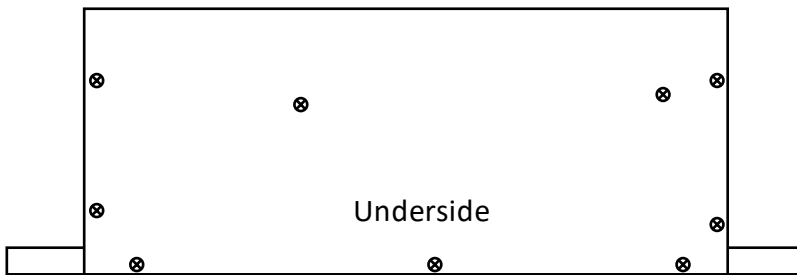

Underside

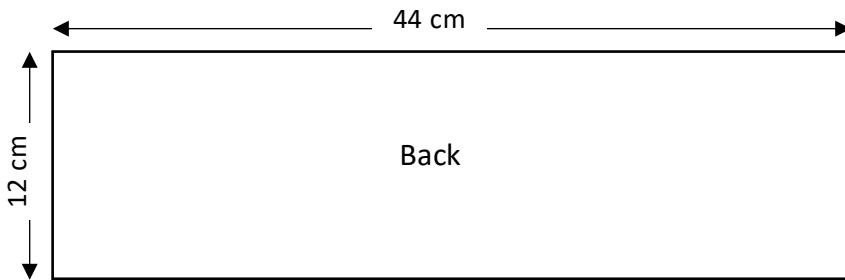

Back

9.5 cm but cut to fit.

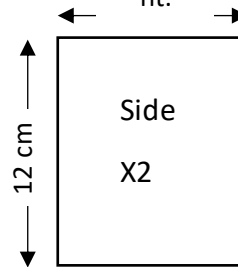

Side X2

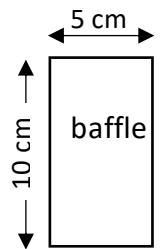

baffle

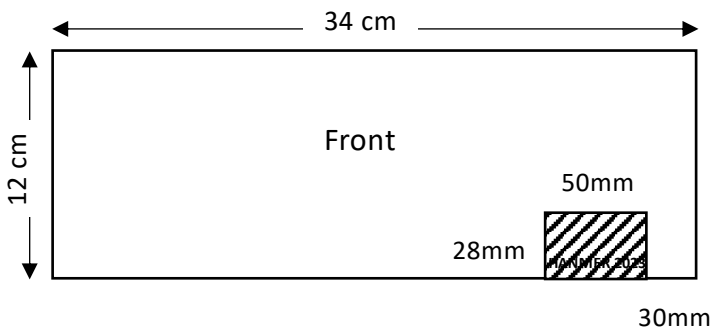

Front

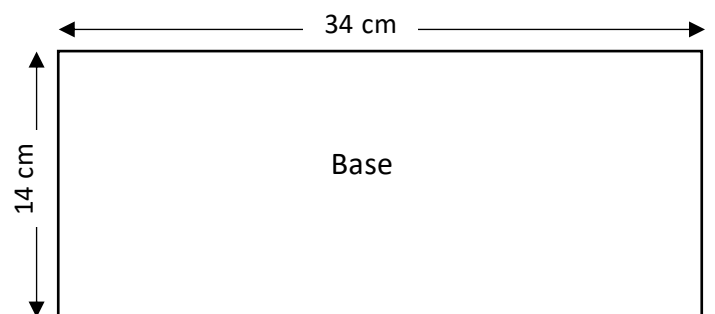

Base

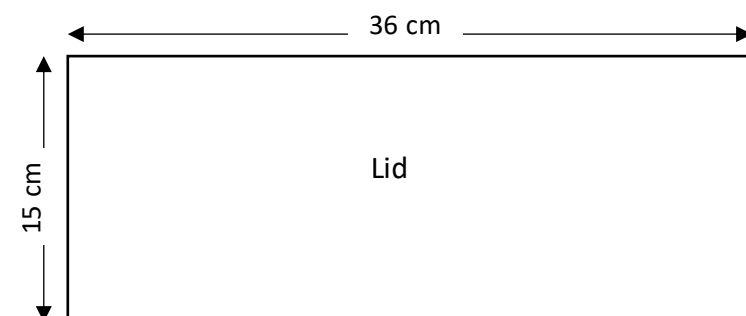

Lid

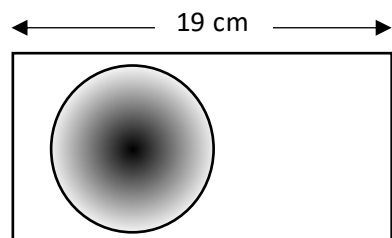

Budgie nest concave cut to fit. This can be bought from the internet.